

MANUFACTURING AND MACHINING SPECIFICATIONS

Effective Date: June 5, 2014
Revision Date: December 21, 2023

Applicant File Number:
F411

Report Number:
F411-20-2-MFG
Edition 10

Applicant:
Wolman Wood and Fire Protection GmbH
Werk Sinzheim E-EBE/WB
Bau 2, Dr.– Wolman – Str. 31-33
76547 Sinzheim, Germany

ATTENTION: Andreas Bolz, Business Manager Fire Protection Materials

APPLICABLE REQUIREMENTS:

CAN/ULC S104-15 (R2020) *Standard Method for Fire Tests of Door Assemblies*
UL 10B (2020) *Fire Tests of Doors Assemblies*
UL 10C (2021) *Fire Tests of Doors Assemblies*
NFPA 252 (2022) *Standard Methods of Fire Tests of Door Assemblies*
UL 9 (2020) *Standard for Fire Tests of Window Assemblies*
CAN/ULC S106-15 (R2020) *Standard Method for Fire Tests of Window and Glass Block Assemblies*

SUBJECT:

MANUFACTURING AND MACHINING SPECIFICATIONS FOR WOLMAN – 20 MINUTE
CATEGORY “C” NEUTRAL AND POSITIVE PRESSURE FIRE RATED FRAMES WITH HOSE
STREAM (PAGES 2-4)

MANUFACTURING AND MACHINING SPECIFICATIONS FOR WOLMAN – 20 MINUTE NEUTRAL
& POSITIVE PRESSURE FIRE RATED WINDOWS WITH HOSE STREAM (PAGES 5-6)

WWW.QAI.ORG
info@qai.org

20-MINUTE FIRE DOOR FRAME:

Materials:

Medium Density Fiberboard (MDF)

- Meeting ANSI A208.2
- Minimum 31 lbs./ft³ density

Hardwood or Softwood

- Minimum 27 lbs./ft³ density

Maximum Sizes:

Swing Type:	Maximum Dimensions		Figure:
	Width:	Height:	
Single Swing	3'6" (1067 mm)	9'0" (2743 mm)	1
Standard Pairs	7'0" (2134 mm)	9'0" (2743 mm)	
	8'0" (2438 mm)	8'0" (2438 mm)	
Double Egress Pairs	Not Permitted		

Note: See 45 minute specification for 10 ft. high frames.

Limitations:

Frame - Single or Double Rabbet Option:

- Minimum frame width: 4-1/2"
- Maximum frame width: Equivalent to wall thickness
- Minimum frame thickness: 5/8" (-1/16")
- Minimum rabbet for door: 1-3/4"
- Minimum stop height: 1/2"
- Minimum stop width: 1-3/16"

Frame - Option with a Kerf:

- Minimum frame width: 4-1/2"
- Maximum frame width: Equivalent to wall thickness
- Minimum frame thickness: 3/4"
- Minimum rabbet for door: 1-3/4"
- Minimum stop height: 1/2"
- Minimum stop width: 1-1/2"
- Maximum door to stop gap: 7/16" (allowance for weatherstrip)
- Maximum frame kerf thickness: 1/8"

Note: Kerfed frame is limited to use with Category A doors only (intumescent in door edges).

Frame Sections:

Frame: Medium Density Fiberboard (MDF) meeting ANSI A208.2 31 pcf density minimum.
Softwood or Hardwood.
Minimum 27 lbs/ft³ density
(See attached drawings)

Frame thickness additions: (See Figure 8):

- Addition of Medium Density Fiberboard (MDF) or Wolman SW20-1 Cores to the backside of the frame components.
- Frame thickness increase is required to fully enclose hardware items such as concealed closers, concealed hinges or electric strikes.

Frame depth additions (See Figure 8):

- Addition of MDF, Softwood or Hardwood to the frame section equivalent to the wall thickness.

Flat Laminated: Hardwood veneer can be laminated to frame faces.
Note: Entire frame can be made from hardwood

Veneer Wrapped: Maximum Thickness = 1/40" veneer may be laminated over MDF.

Hardwood Facings: Hardwood Facing adhered to the face of the frame leg

Stops:

Single Rabbet or Double Rabbet (applied: flat laminated or "T" Stop).

Material: MDF, Softwood or Hardwood with minimum density of 27 lbs./ft³ density

Stops must be applied with a small bead of glue or silicone behind the stop and fastened with finishing nails at 12" on center. Stops may be field applied to ensure proper fit with fire door.

Adhesives:

Any PVA or PUR listed adhesives for use in 20 minute fire-rated door assemblies.

Follow the adhesive manufacturers' instructions and bulletins for mixing, application rates, pressing parameters, cure temperatures, and safe use practices.

Sidelites and Transoms / Muller Assemblies:**Muller frames:**

One frame will be active opening and the other a fixed sidelite fastened to the frame (see Figures 2 and 3). Sidelites can be muller to one or both sides of the door frame.

Full frame muller between 2 half width frames:

This muller assembly is a full frame that is joined to 2 half width frames (see Figure 3).

Transoms

Transoms can be muller above the active opening effectively reducing the overall height of the active opening. Glazed transom with glazing installed directly in the frame is not permitted. Transom panel shall be 1 3/4" thick door construction and may contain a lite, panel is fastened to the frame sections on all for sides.

Sidelites

There are four sidelite options, the options are as follows:

1. Fully fastened Wolman 20 min rated door panel
2. Fully fastened Wolman 20 min rated door panel containing a lite (meeting the F411-1 Listing)
3. Wolman door core panel (limited sizing to the tested exposed core area – 34" x 88" or 40" x 76")
4. Glazed frame – Wolman clip system using 3/16" ceramic glazing - maximum single lite size – 24" by 48". Combination lites of max 2 units wide or 2 units high, or Combination lite consisting of 4 units - 2 wide by 2 high. See Figure _

20-MINUTE FIRE WINDOW:**Materials:**

Proprietary Wolman Laminated Core:
Palusol SW 45-1 Core (0.6250" Thickness)

- Composite continuous core

Proprietary Wolman Edge Sealing Material:

Palusol 100 (0.0787" Thickness)
Palusol 104 (0.1575" Thickness)

Maximum Sizes:

One Layer of SW 45-1 Core: (See Figures 4,5)

Window Type:	Maximum Dimensions		Figure:
	Width:	Height:	
Single Unit Window	2'0" (610 mm)	4'0" (1219 mm)	4,5
Combination Window	2 units wide, 2 units high or 4 units – 2 high by 2 wide, connected together		

Limitations:

- Minimum Frame Width: 4-1/2"
- Maximum Frame Width: Equivalent to wall thickness
- Minimum Frame Thickness: 5/8" [Wolman SW 45-1 Material]
- Maximum Frame Thickness: 1 1/2" [Wolman SW 45-1 Material + MDF]
- Minimum Stop Height: 1/2"
- Minimum Stop Width: 3/4"

Frame Sections:

Material:

- Single Layer of SW 45-1 Core.
- Palusol 100 or 104 inset in the frame section, glazed side, around the perimeter of the glazing, (same width as Wolman Glazing Clip).

Frame depth additions:

- Additional MDF may be added to increase section thickness to a maximum of 1 1/2".

Flat Laminated: Hardwood, Maximum Thickness on frame face = 1/8"

Veneer Wrapped: Minimum Thickness = 1/40" Veneer may be laminated over MDF.

Glazing (Listed and labeled for rated opening):

- Glazing material shall be 3/16" ceramic listed and labeled for rated opening.
- Glazing installed in accordance with the installation instructions outlined below and on Figure 4.
- Glazing details:
 - Maximum window opening 24" x 48" (Width x Height) with Wolman vision kit using Listed 3/16" ceramic glazing [See Figures 4 and 5].
 - Wolman Glazing Clips used at 8" maximum spacing, fastened using 3/4" staples or flat head nails.
 - Silicone sealant must be used around perimeter of glass (between the glass and frame).

Stops:

- Minimum 1/2" x 3/4" rectangular wood stops made from MDF or solid wood with specific gravity ≥ 0.44 @ 12% MC, 27 PCF density
- Stops are to be machined with a relief to allow for Wolman Glazing Clips.
- Single layer of PVC encapsulated Palusol 100 or 104 is applied to two surfaces of the stop. Wood veneer is permitted to be used to conceal Palusol.
- Stops are fastened using 1/2" wide 3M double sided tape 5958 FR VHB applied in 1" strips to each glazing clip.

Adhesives:

- Any PVA or PUR listed adhesives for use in 45 minute fire-rated door assemblies.
- Follow the adhesive manufacturers' instructions and bulletins for mixing, application rates, pressing parameters, cure temperatures, and safe use practices.

Arched Top Frames:

- Not permitted, (See 45 minute specifications for arch top frames).

Mulled Assemblies:

- Not permitted, except for sidelites and transoms as shown in Figures 2 to 7 in the enclosed drawings.

Machining**Hinge and Strike Plates:**

All hinges and applicable hardware must be fire rated for use in openings at or above the fire rating of the frame system being installed. Preparation for hinges and hardware shall be made in accordance with NFPA 80, the hinge manufacturer's installation instructions and templates.

Electric Raceways:

A 1/4" diameter hole is permitted anywhere below 40" above the floor on the hinge or latch frame leg. Wire can then be routed through the hole for electronically controlled hardware. The hole may be left open or sealed with silicone caulking.

Mortised Door Closer:

Concealed closer allowed in the frame header. Maximum 2-1/6" x 3-5/8" x 12" pocket dimensions lined with Interdens Type 15 on all 5 sides.

Minimum 3/8" frame header thickness above the concealed closer pocket [See Figure 11].

Mortised Electric Strike:

Mortise electric strike allowed, Maximum mortise depth 1 1/2", maximum mortise height 3 1/2" [See Figure 13].

Mortised Electric Power Transfer Unit:

Permitted to be installed below the latch level, shall be listed for use in wood doors and tested to UL 10C.

Concealed Hinges

Concealed SOSS and TECTUS hinges are permitted. Frame section shall be built up to encase hinge body. [See Figure 14].

Installation Instructions

Shims need to be installed as per the drawing in Figure 1. Silicone caulking applied between the jamb and rough opening on both sides of the assembly. Each hinge needs to be fastened through the shim into the frame with at least #12 x 2-1/2" screws. The frame can then be fastened at all non-hinge shim locations with 2" finishing nails. Installation instructions shall be shipped with frame or fire window shipment. [See Figure 15].

Test Reports:

Test Report #	Date Issued
QAI Test Report # T848-2	June 2, 2014
QAI Test Report # T848-20b	June 27, 2017
QAI Test Report # T848-20c	June 27, 2017
QAI Engineering Evaluation # F411-5-8	April 16, 2015
QAI Engineering Evaluation # F411-5-14	March 17, 2016
QAI Engineering Evaluation # F411-5-27	October 16, 2017
QAI Engineering Evaluation # F411-5-28	October 16, 2017
QAI Test Report # T848-24C	April 5, 2019
QAI Test Report # T848-24E	April 16, 2019
QAI Engineering Evaluation # T848-24H	April 25, 2019
QAI Engineering Evaluation # T848-24K	April 25, 2019
QAI Engineering Evaluation # T848-24J	May 7, 2019
QAI Test Report # T1470-3C	March 24, 2022
QAI Engineering Evaluation # T1470-4C	April 25, 2023
QAI Engineering Evaluation # T1470-4E	April 25, 2023

APPENDIX

Page	Title
A1	20 minute rated door frame assembly details
A2-A8	20 minute rated mulled assemblies and sidelites
A9	Frame facings
A10	Options for extending frame depth and thickness
A11	Options for extending frame leg length
A12	Concealed Closer Preparation
A13	Electric Strike Preparation
A14	Concealed Hinge Preparation
A15	Installation Instructions

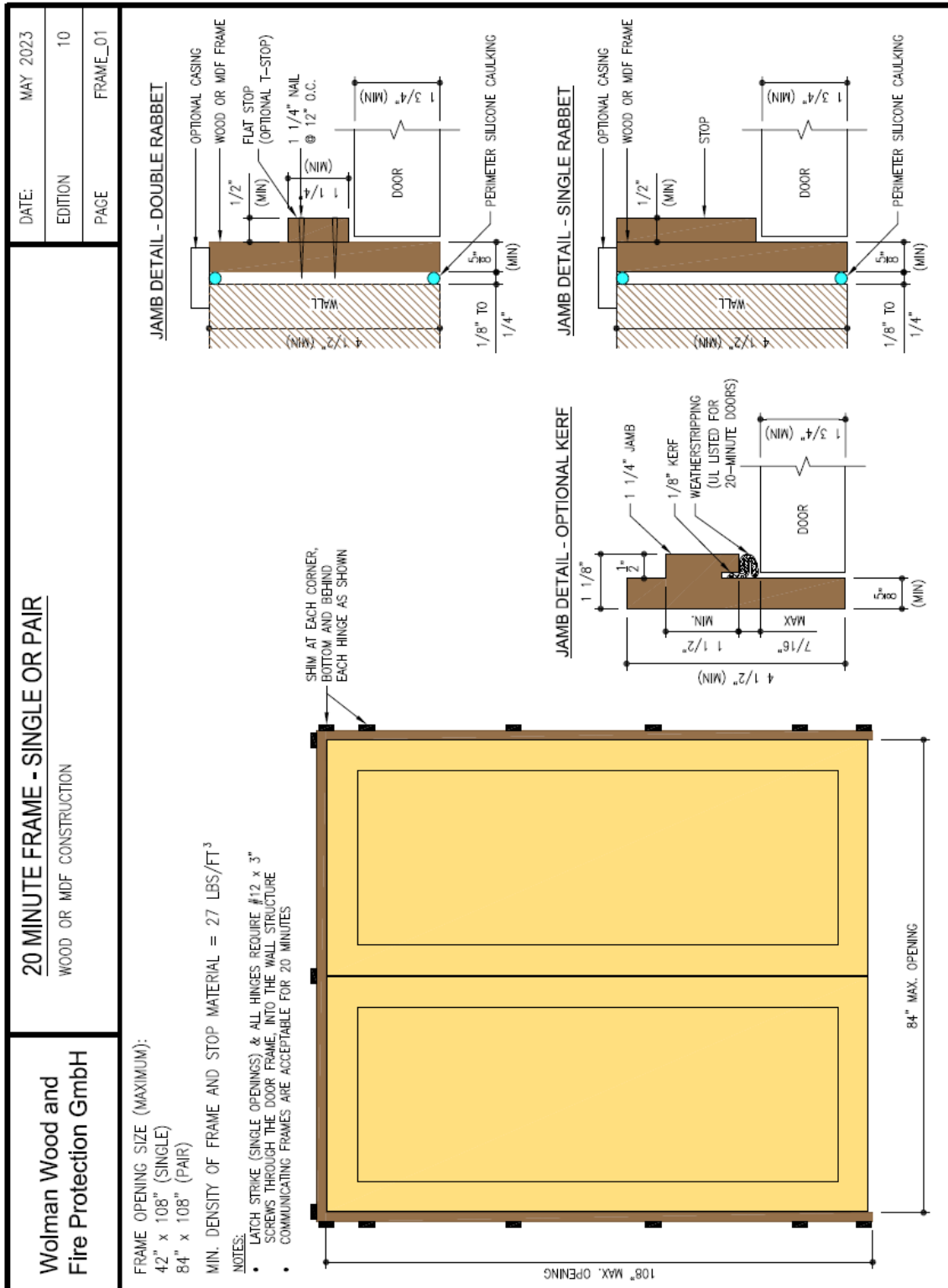

Figure 1: 20 minute rated frame assembly.

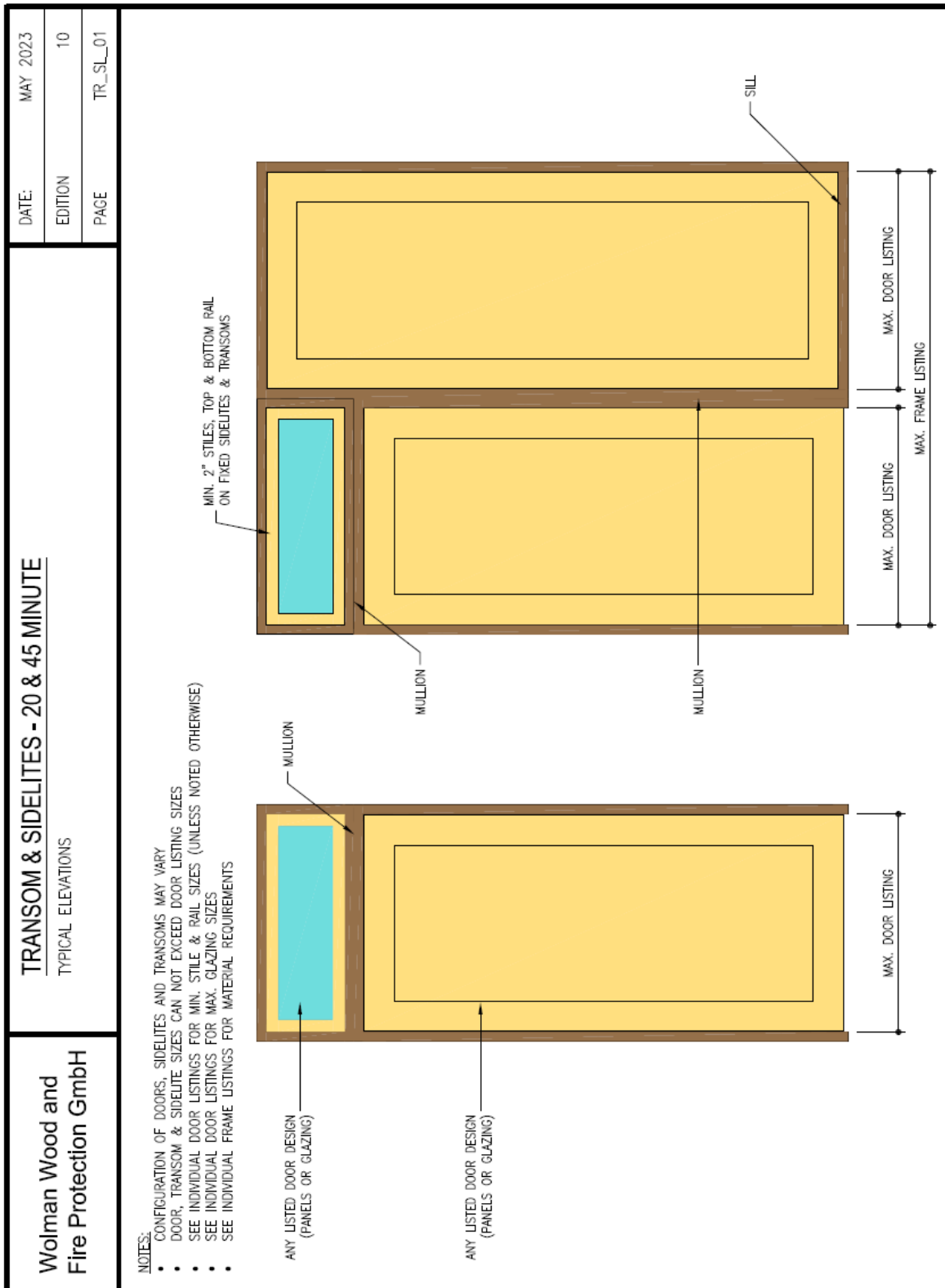

Figure 2: Single or mullioned frames with sidelite and/or a transom.

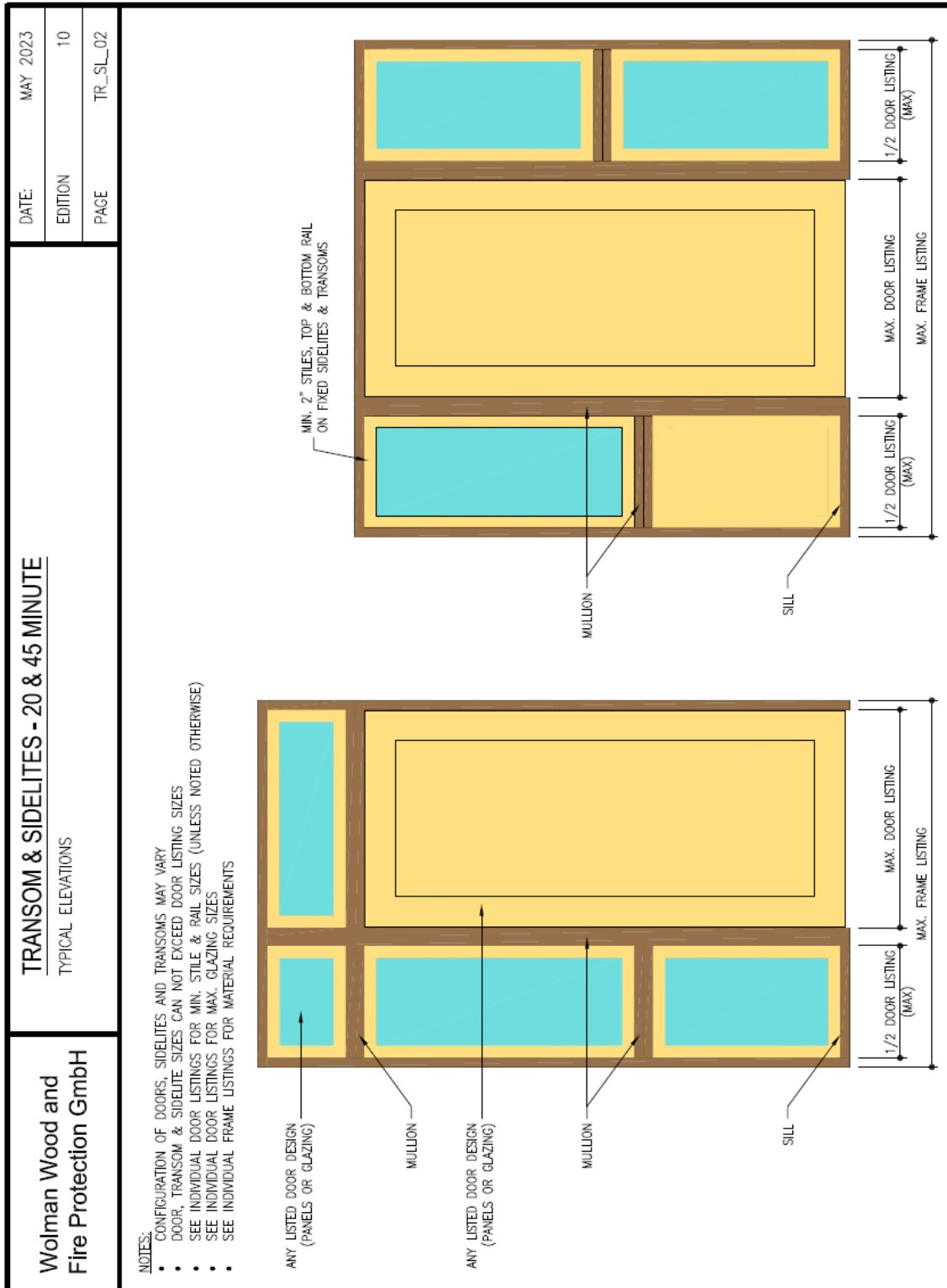

Figure 3: Mullioned frames with divided sidelite and a transom (left).
Mullioned frames with divided sidelites (right).

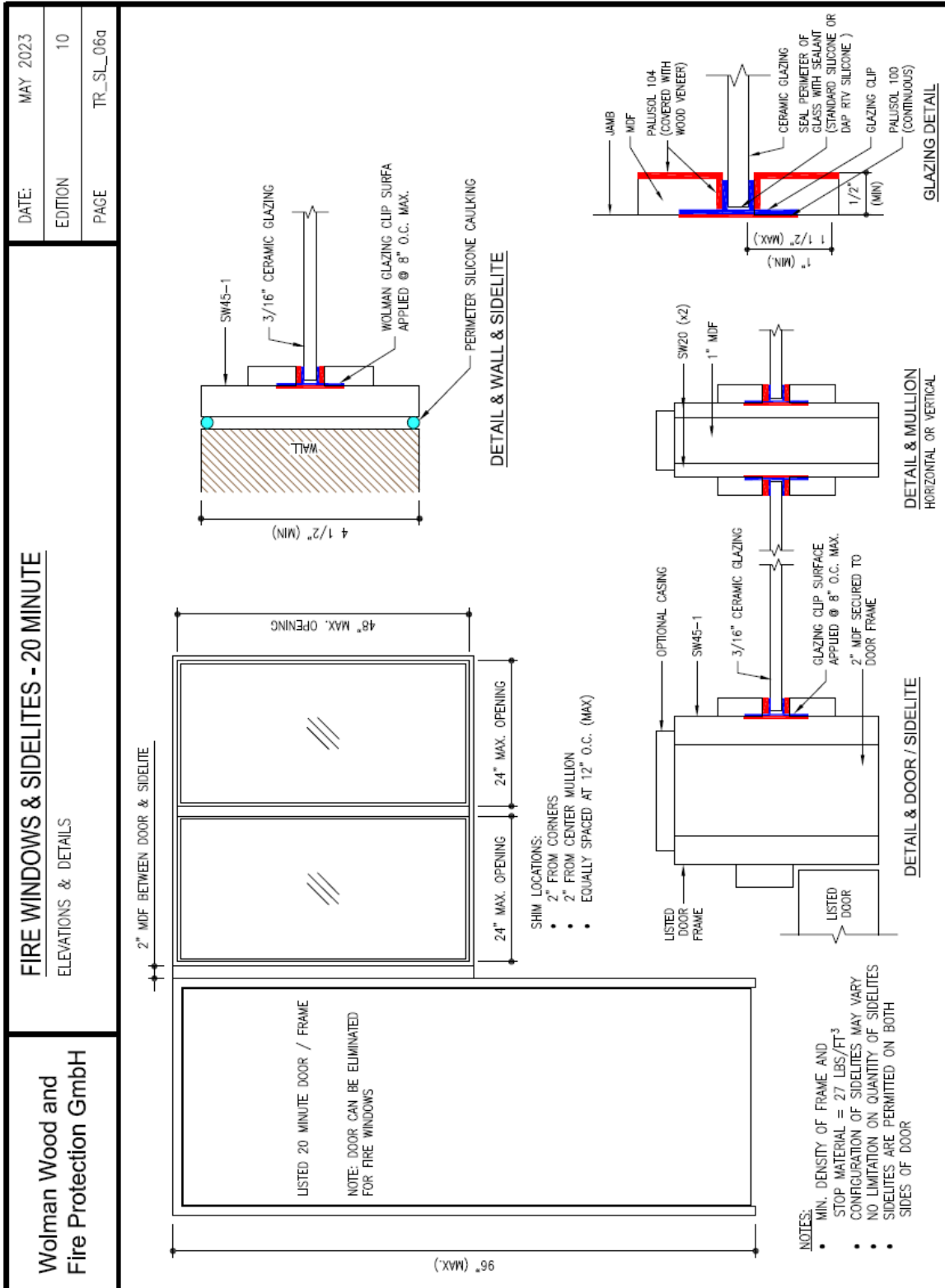

Figure 4: Sidelights with direct set glazing using clip system

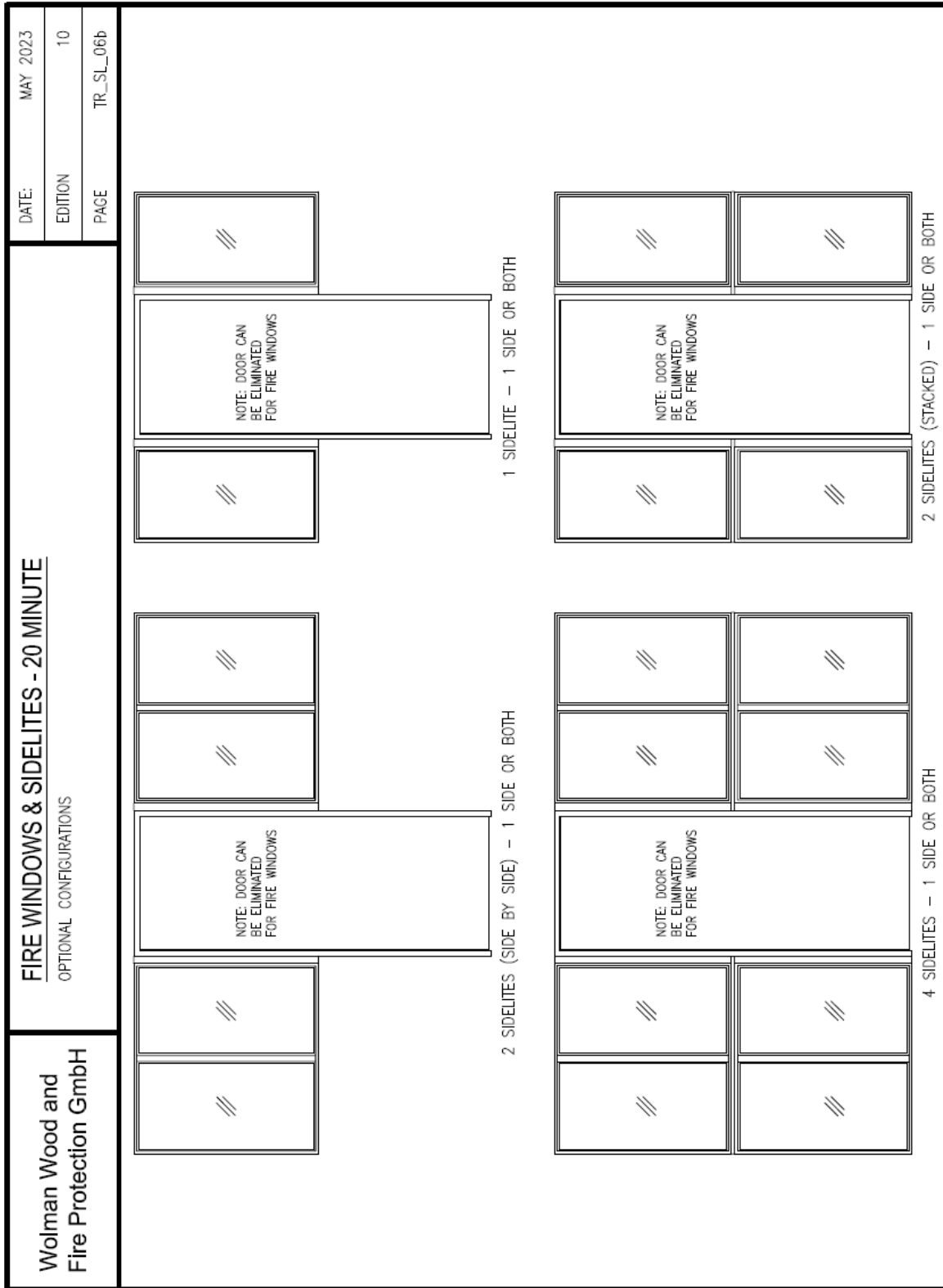

Figure 5: Sidelight configurations using direct set glazing using clip system

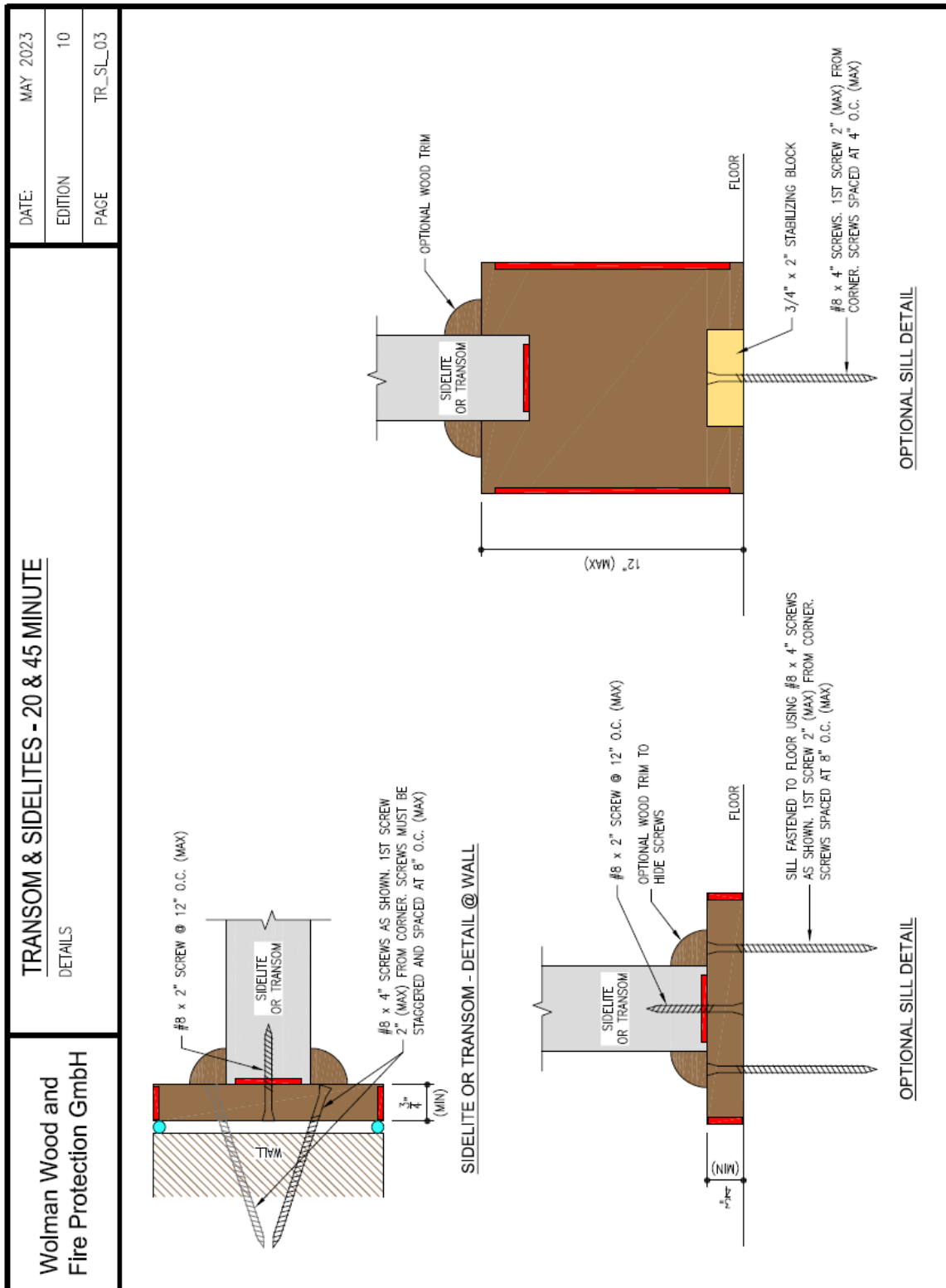

Figure 6: Connection details for glazed panel transoms and sidelights.

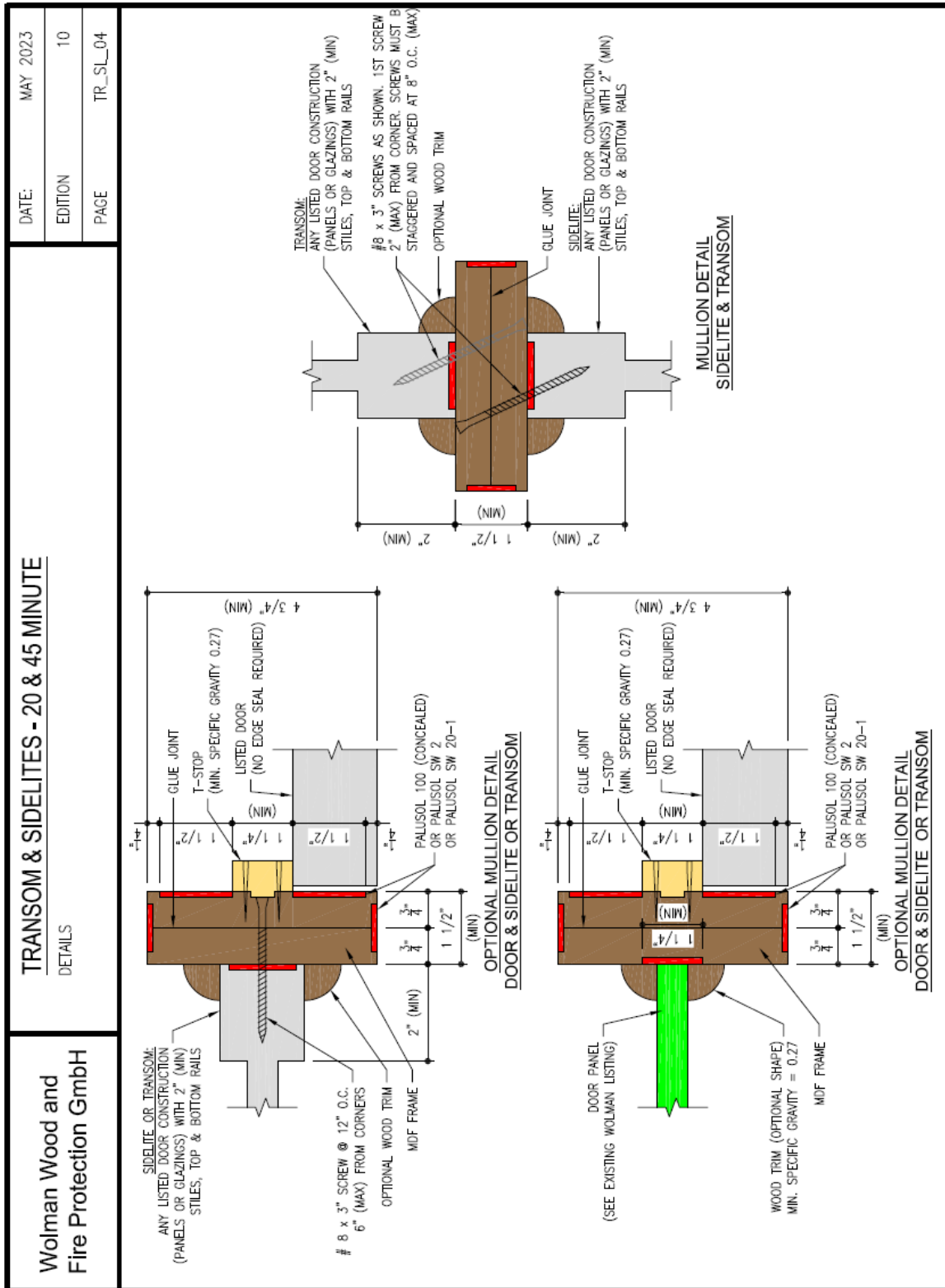

Figure 7: Frame connection with glazed panel sidelite, also for clip system direct set glazing.

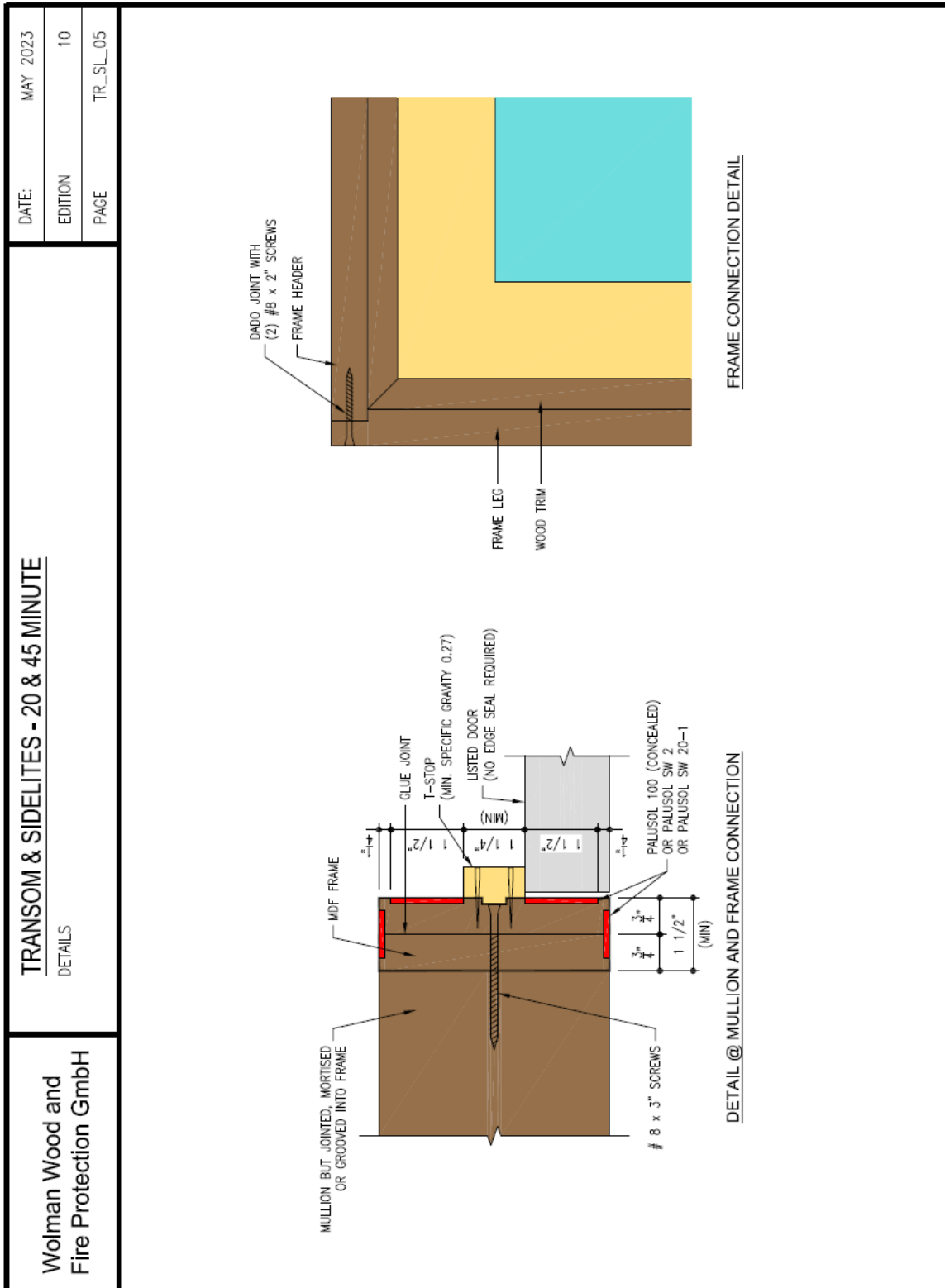

Figure 8: Mullion and frame connection details.

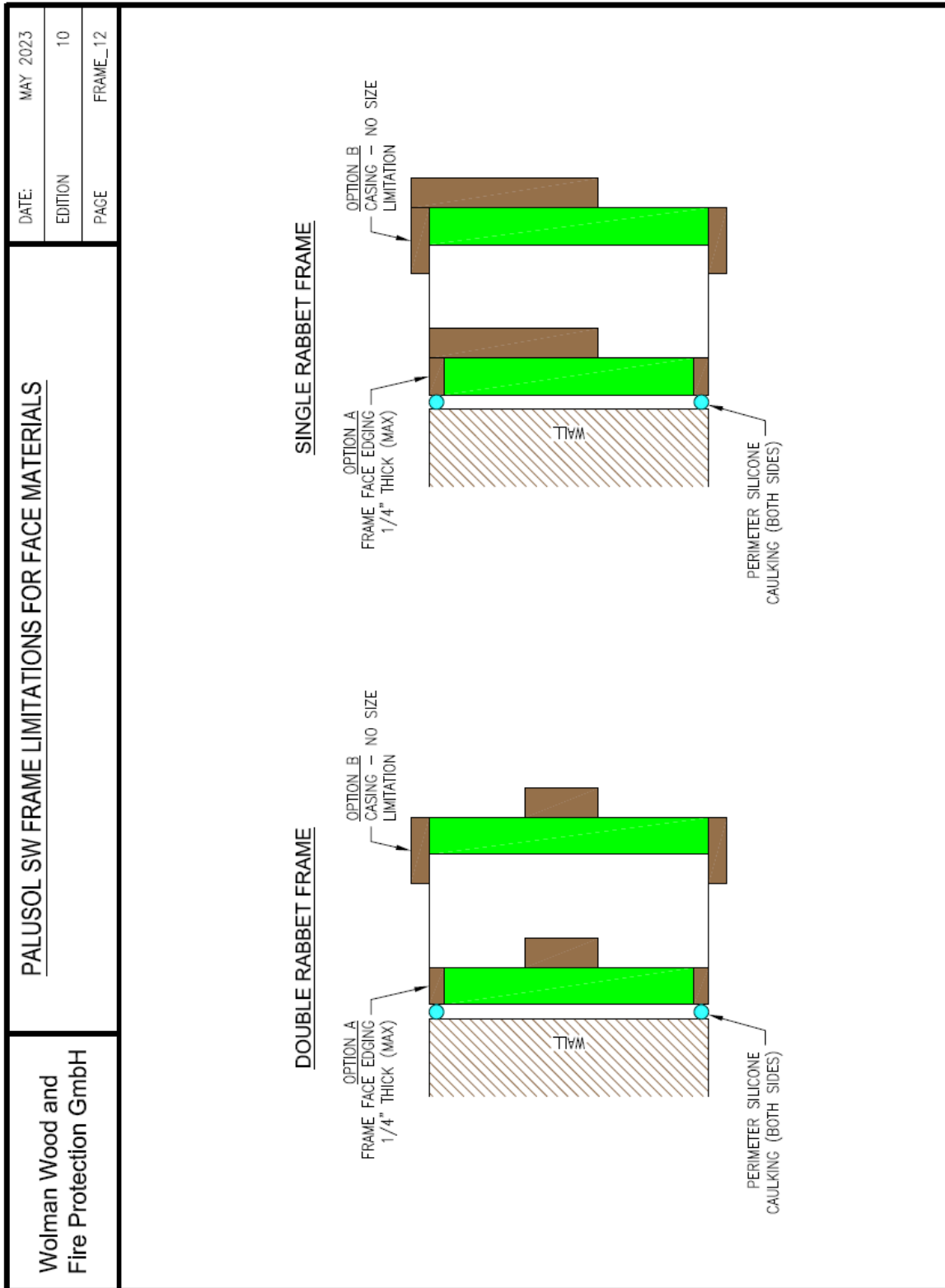

Figure 9: Frame facing options.

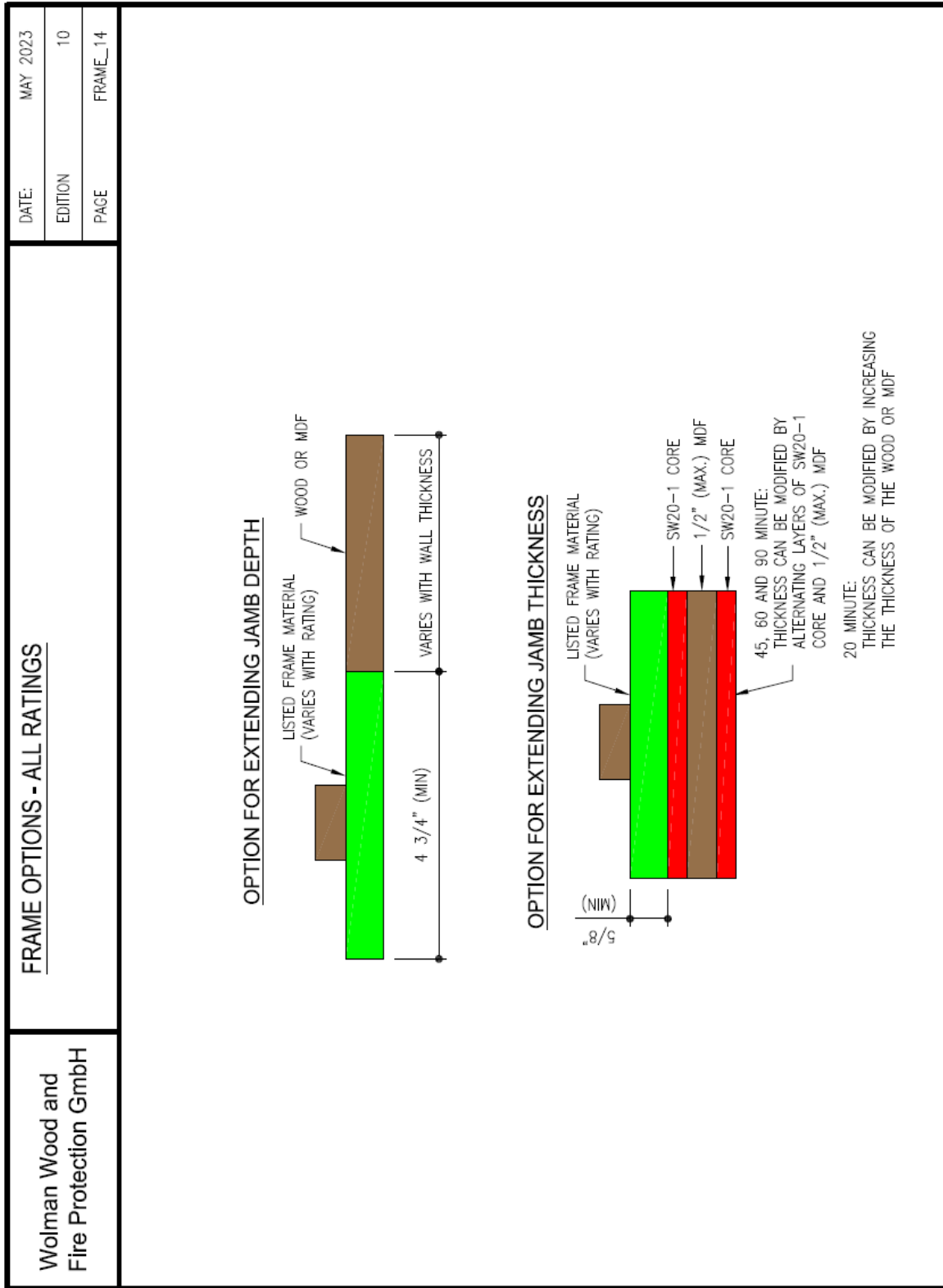

Figure 10: Options for extending jamb depth and thickness.

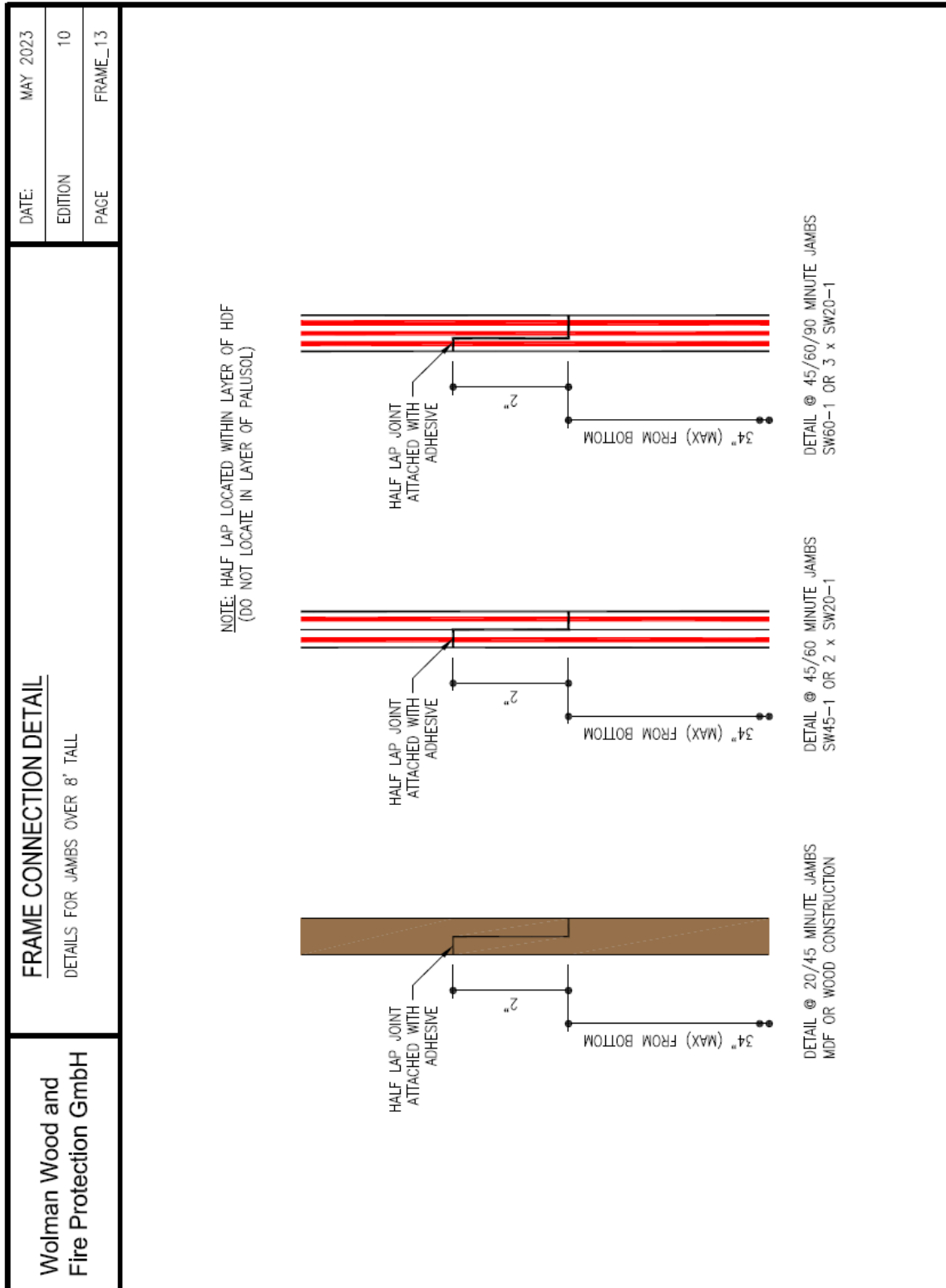

Figure 11: Options for extending jamb leg length.

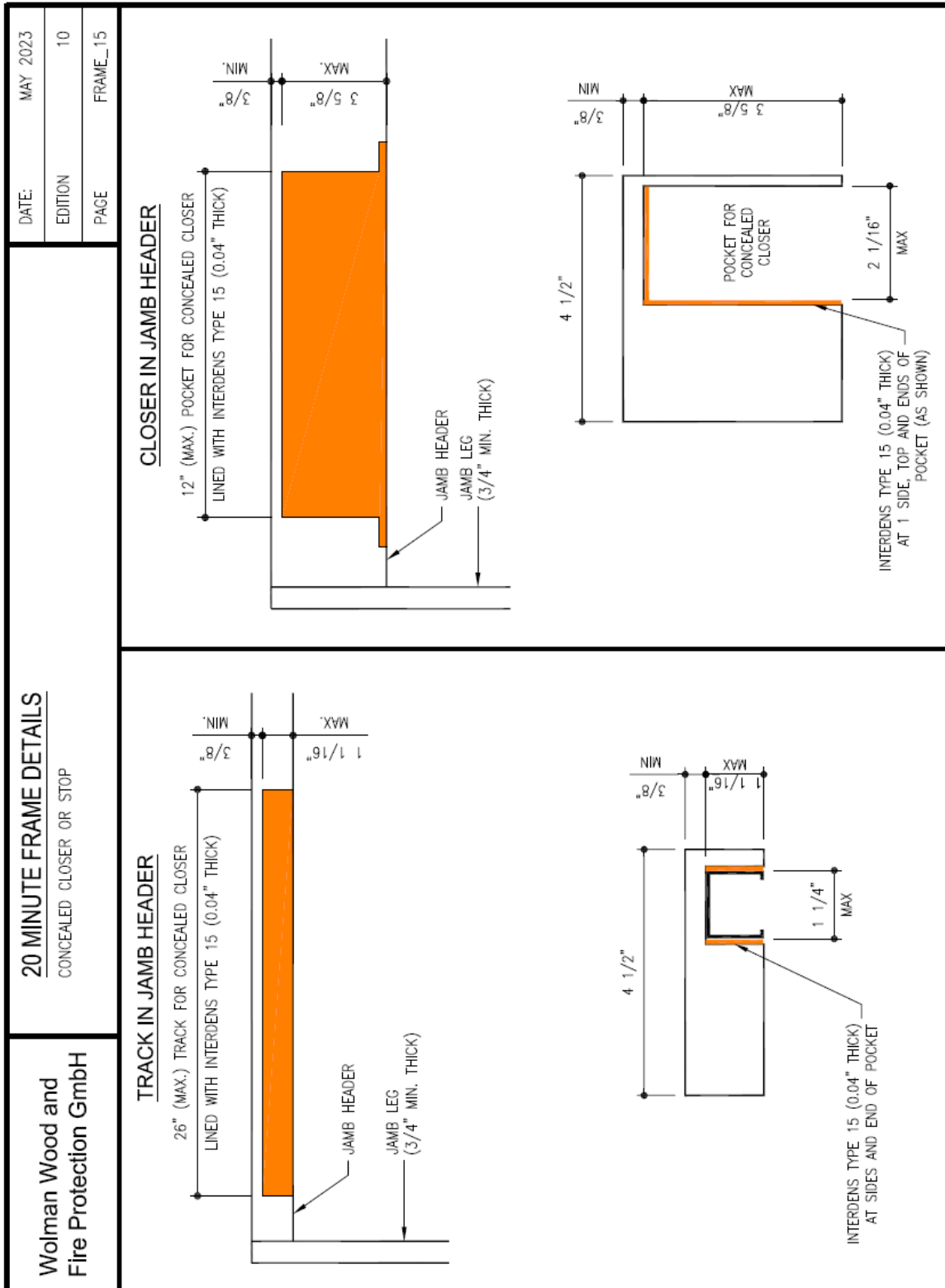

Figure 12: Concealed closer preparation details

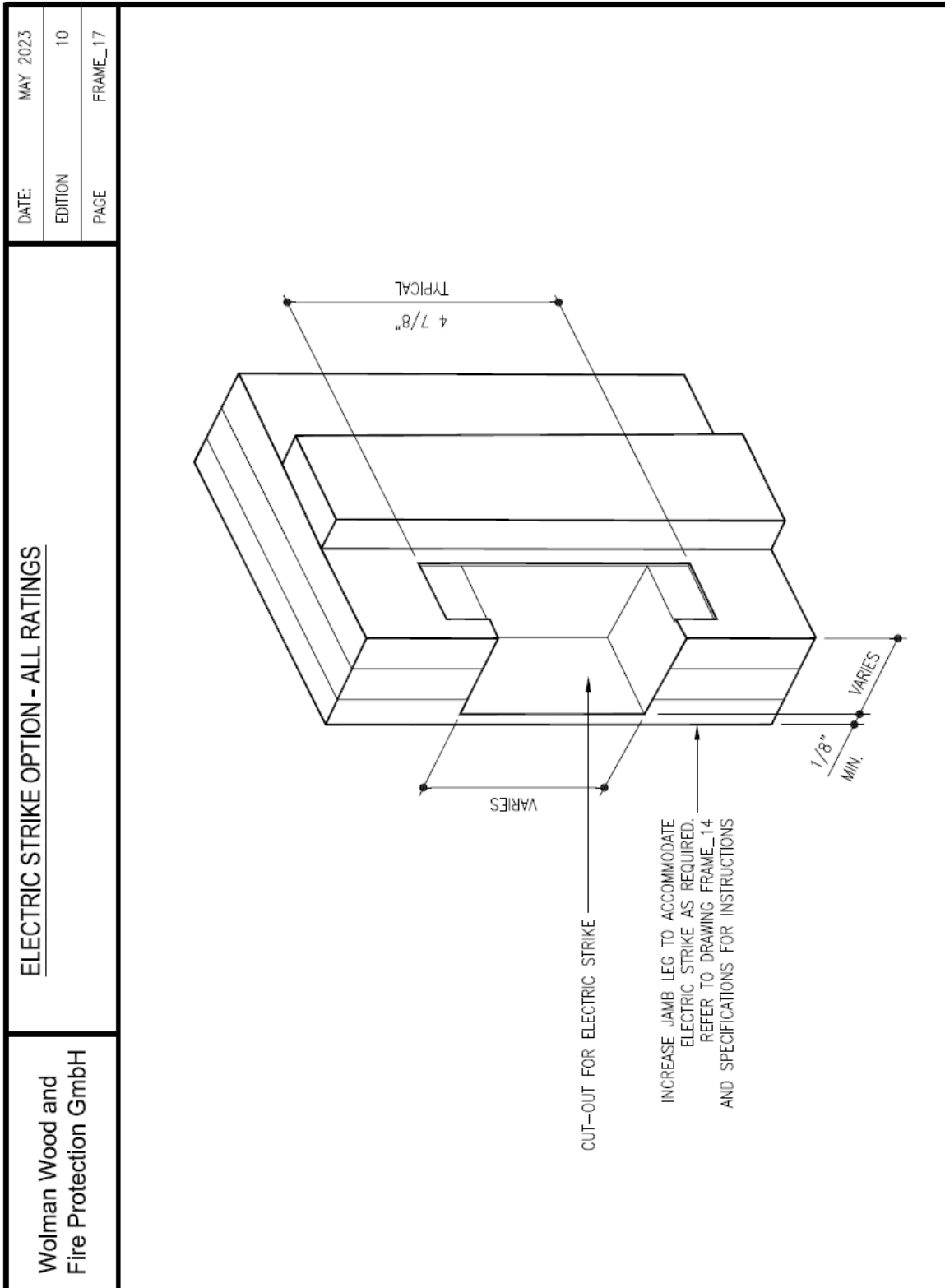

Figure 13: Electric Strike preparation details

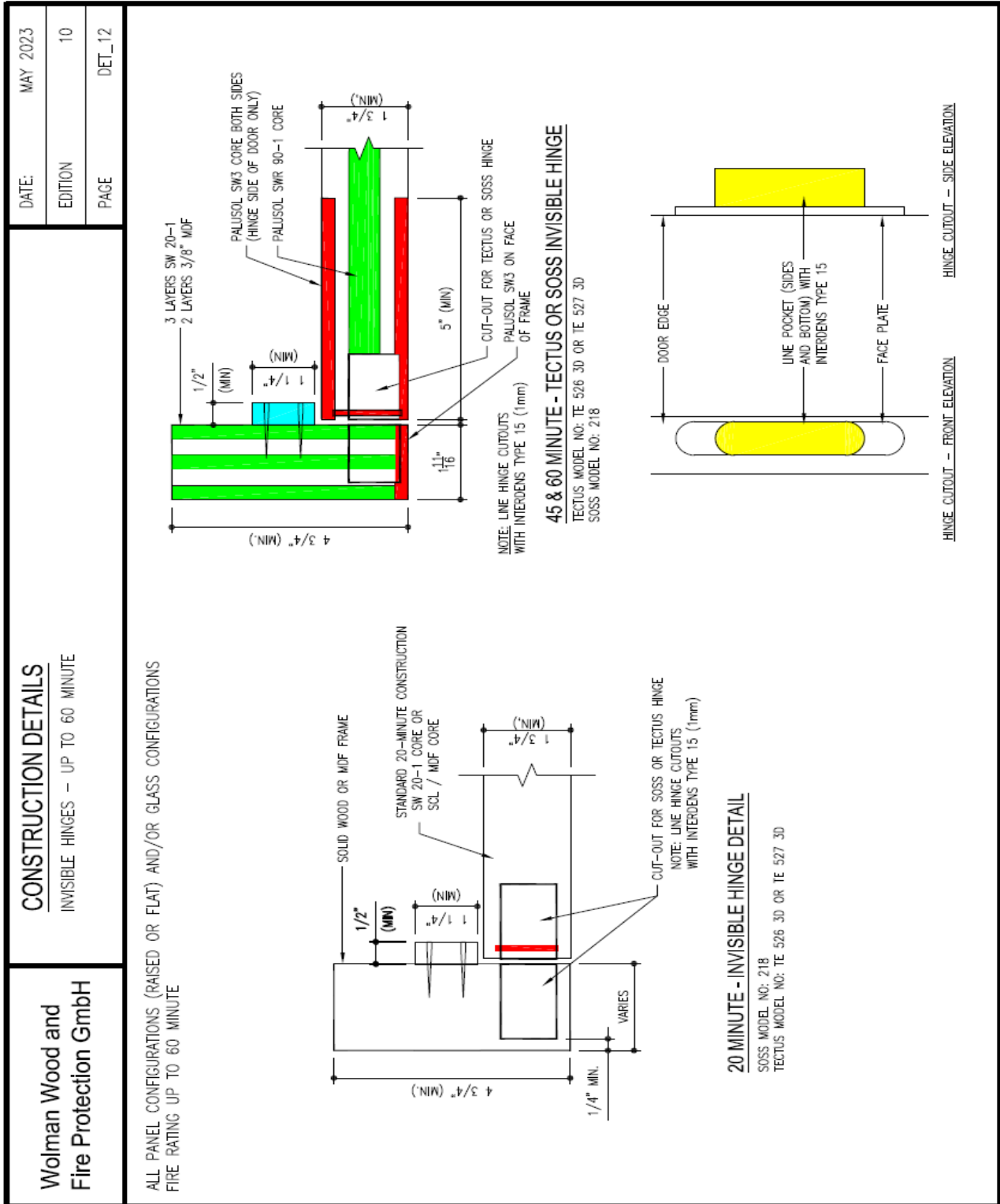

Figure 14: Concealed Hinges

<p>Wolman Wood and Fire Protection GmbH</p>	<p>FIRE RATED FRAME INSTALLATION INSTRUCTIONS</p> <p>20, 45, 60 AND 90 MINUTE FIRE RESISTANCE RATINGS</p>		<p>DATE: MAY 2023</p> <p>EDITION 10</p> <p>PAGE FRAME_18</p>
<p>A. Frame header to leg connections</p> <p>Use minimum four (4) No. 8 or larger wood screws to connect frame legs to header. Screws shall penetrate at least 1" depth into header, and be evenly spaced. Pre-drill holes. For frames with depth larger than 6", add an additional screw.</p> <p>B. Shim Space, Shims and Fastening Frame to Wall</p> <p>Maximum 1/4" shim space. Shim at each hinge, latch and screw fastening location. Fasten frame near base and every 18" to 20" of frame leg. Shim and fasten header 3" from edge, and at the center of door leaf. For pairs of doors, this will require six fastening points per header.</p> <p>Fasten frames with two (2) No. 8 or larger wood screws or finishing nails per fastening location. One screw or nail is hidden behind the stop, the other is located in the door rabbet. The screws shall be long enough to penetrate at least 1" into the wall studs.</p> <p>C. Preparation for installation in steel stud wall construction</p> <p>The steel stud opening shall be lined with minimum 1/2" plywood or solid wood to provide holding strength for the frame screws or nails. The wood lining shall be fastened with screws every 18" to 20" with screws installed through the back side of the steel studs and header track. The gypsum wallboard will extend to cover the exposed edge of wood lining.</p> <p>D. Preparation for installation in concrete or masonry construction</p> <p>The opening is lined with minimum 1 1/2" wood stud attached to the masonry with lag bolts or equivalent fastening method every 30" maximum. The exposed 1 1/2" faces of the wood lining is protected using Type X gypsum wallboard, appropriate for the wall rating, on both sides of the wall.</p> <p>E. Caulk and Casing</p> <p>Once the frame is installed and fastened, the shim space is sealed with 1/4" depth bead of acrylic sealant (20 minute rated frames) or silicone sealant (20 to 90 minute rated frames) on both sides of the wall.</p> <p>Wood casing or molding of minimum 3/16" is attached to the frame to cover the shim space.</p> <p>F. Hardware Installation and Security</p> <p>The two hinge screws closest to the door stop shall be replaced with wood screws that penetrate at least 1" into the wall stud, for each hinge. The two screws for the strike plate for the latch are also required to penetrate at least 1" into the wall stud. These screws are required in all installations, for all fire resistance ratings.</p>	<p>The diagrams illustrate two types of frame connections. The 'Butt Joint' shows two frame legs meeting at a 90-degree angle, secured with two screws. A note indicates the joint can be horizontal or vertical. The 'Dado Joint' shows a frame leg inserted into a groove (dado) in the frame header, also secured with two screws. Labels include 'Frame Header', 'Frame Leg', and 'Stop'.</p>	<p>This diagram shows a cross-section of a door jamb installation. It labels the 'Casing', 'Jamb Leg or Header', '1/4" Max. Shim Space', 'Door', 'Wall', and 'Perimeter Sealant'. The shim space is highlighted in green, and the sealant is shown as a bead between the jamb and the wall.</p>	

Figure 15: Installation Instructions